

METALCORP

Everything in Steel

THE RURAL BRAND
FOR THE LAND

EOFY FRENZY!

HURRY ENDS JUNE 30TH 2026

CLICK HERE TO CALL METALCORP



5km x 4 Barb Wire FENCE PACKAGE

What You Get -

- ✓ Barb Wire 1.8mm HT 500m x 40
- ✓ Black Fence Post 1800mm x 1,000
- ✓ Post Clip with Tool 250 x 16
- ✓ Wire strainer & toolbox

\$12,275

BONUS WIRE STRAINER AND TOOLBOX with purchase



2km 8-90-15 FENCE PACKAGE

What You Get

- ✓ Black Fence Post 1650mm x 500
- ✓ METALMAX® 8-90-15 2.5mm Heavy Gal 100m x 20
- ✓ Barb wire 1.8mm HT 500m x 4
- ✓ Plain wire 2.5mm HT 1500m x 4
- ✓ Post Clip with Tool 250 x 2
- ✓ Clips 1000 x 6
- ✓ Hinge joint strainer

\$10,185

BONUS HINGE JOINT STRAINER with purchase



METALMAX



BUY MORE SAVE MORE DEALS ON 400+, 800+ & 1200+ PACKS

TOUGH HEAVY-DUTY POST MADE TO MATCH THE HARD AUSTRALIAN CONDITIONS.

Black Bitumen: 60-80 microns
Hot Dipped Gal (500g/m²)

Fence Posts Black
South QLD 1.85kg/m **400+ 800+ 1200+
Black 1650mm-----\$6.80*----\$6.42----\$6.10
Black 1800mm-----\$7.40*----\$7.03----\$6.67

Fence Posts Black
North QLD 2.05kg/m **400+ 800+ 1200+
Black 1650mm HD-----\$6.80*----\$6.42----\$6.10
Black 1800mm HD-----\$7.40*----\$7.03----\$6.67

Fence Posts Gal
South QLD 1.85kg/m **400+ 800+ 1200+
Gal 1650mm-----\$8.20*----\$7.76----\$7.36
Gal 1800mm-----\$9.00*----\$8.47----\$8.05

Fence Posts Gal
North QLD 2.05kg/m **400+ 800+ 1200+
Gal 1650mm HD-----\$8.20*----\$7.76----\$7.36
Gal 1800mm HD-----\$9.00*----\$8.47----\$8.05
*single buy prices. **North QLD & South QLD posts specified

ASK FOR BULK RATES ON OUR ENTIRE RANGE

HORSE YARD DEALS



20m Round Horse Yard
Includes
29 x panels
1 x gate in frame
60 x pins

\$2,815

25m Round Horse Yard
Includes
37 x panels
1 x gate in frame
76 x pins

\$3,529

30m Round Horse Yard
Includes
44 x Panels
1 x Gate in Frame
90 x pins

\$4,155

20 PACK DEAL!



NTH QLD 20 PACK DEAL FARMHAND Panels
6 bar. Gal. 59mm x 30mm x 2.0mm oval rail. 1800mm (h) x 2100mm (w)
\$99.00 each single buy.

\$1,880 pack

Charters Towers & Mt Isa only

STH QLD 20 PACK DEAL FARMHAND Panels
6 bar. Gal. 59mm x 30mm x 1.6mm oval rail. 1800mm (h) x 2100mm (w)
\$90.00 each single buy.

\$1,700 pack

Toowoomba & Bundaberg only

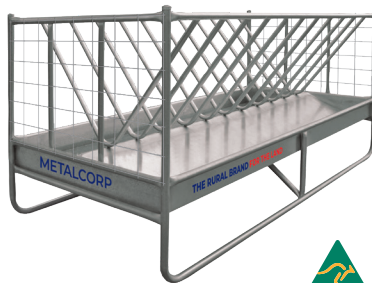

3m Heavy Duty Hay Rack
Holds 2 x round bales or 1 x 8ft square bale.
Gal construction. \$1,570.

METALCORP MATES PRICE! \$1,490 SAVE \$80!



STOCKSAFE® 2m x 4m Unrated Cattle Grid **\$3,078**
Mounting brackets for side wings. Farm use only.



Grid Wings
Attaches to the sides of a cattle grid.
\$287

"Let's keep in touch!"

Follow Metalcorp on Instagram & Facebook



JOIN METALCORP MATES TO SAVE & ALSO TO KEEP UP TO DATE WITH OUR EXCLUSIVE OFFERS & DEALS.

Terms & Conditions: All prices unless otherwise stated are inclusive of GST. All products subject to prior sale. E&OE. Freight extra to branches and distributors. Some items not stocked at all outlets. Rainchecks available on select products only. Images for illustration purposes only. While stocks last. Price valid from 16/05/26 to 06/30/06/26. Metalcorp is a registered trademark of BlueScope. Australian made items marked with Australian Made symbol where relevant. Not all Australian Made items may be made from 100% Australian made product. All Metalcorp supplies are subject to Metalcorp Standard Conditions of Sale available at <https://metalcorpsteel.com.au>.



JOIN NOW

CATTLE YARD RANGE

CLASSIC PLUS® Crush

Heavy duty cattle crush engineered for maximum efficiency and safety

Designed to immobilise cattle quickly, effectively and securely using a robust headball system and dual parallel squeeze mechanism. These features reduce stress for both the livestock and the operator. Made in Australia using premium quality Australian steel, this crush delivers durability and reliability to withstand the toughest of conditions.



Scan to learn more

\$11,495

Ex Toowoomba branch.
Freight extra to other branches.



- 1 Offside operation available on request.
- 2 All welds painted using 98.5% pure zinc spray.
- 3 115mm x 42mm non-bruise cattle rail.
- 4 Ratchet operated squeeze.
- 5 Walk-through vet section.
- 6 Powder coated handles.
- 7 Slam latch enables quick hands free closing.
- 8 Increased lower vet gate height to reduce risk of kick back from the animal.
- 9 Foot operated lower vet door (operating side).
- 10 Anti-reverse mechanism has 850mm of adjustment.
- 11 Pressed Gal sheeting.
- 12 Split operating gates on both sides.
- 13 Base 75mm x 50mm x 4mm.
- 14 Upright frame 75mm x 50mm x 2.5mm.
- 15 All 50mm x 50mm RHS are 2.5mm.
- 16 Metalcorp crushes come standard with chin bar.
- 17 Forward & rear ratchet operated headball.

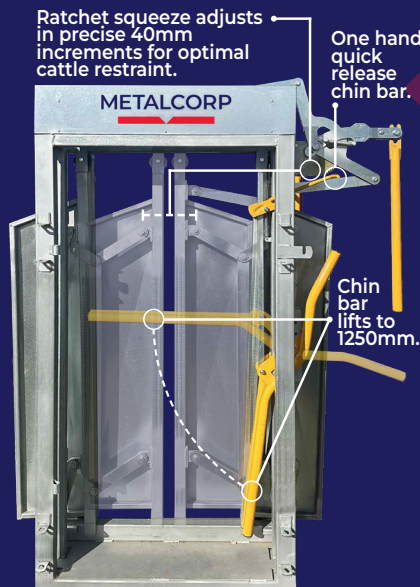
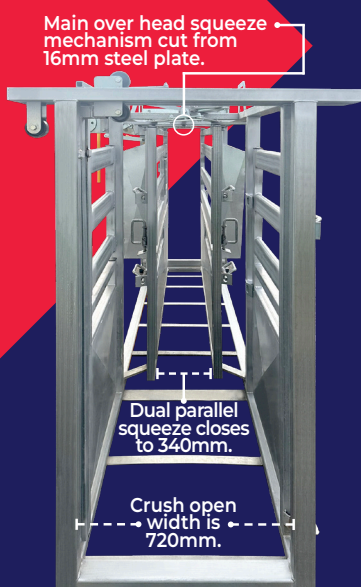

16mm BISALLOY® Wear 450 steel plate ratchet and pawl with dual locking springs. All components precision cut and zinc plated.



75mm oil-able cast iron rollers.



Includes 16 grease nipples ensuring smooth operation.



All nuts are NYLOC.



All hinges are a solid 20mm thick pin with removable linch pin for complete access.



Needle gate opening 440mm x 660mm.



Fully sheeted telescopic rear slide gate with one hand function. Helps create a blind race to reduce stress on livestock.



Drop away handles can be easily locked into position.



Main side doors operate separately or lock together with 20mm vertical slam latch.



Zinc-plated 20mm slam latch with stainless steel springs.

CATTLE YARD RANGE

Calf Cradle

Catch, Restrain, Roll, Work and Release them. Robust & Durable. Strong ratchet latch. Automatic opening gate. Nearside / Offside Compatible.

\$4,395



2 Section Calf Race

Offers a reliable solution for streamlining calf movement during sorting, tagging, or veterinary work. 4.2m long race / 1.7m long magazine. Internal dimensions 450mm wide x 1160mm high. Will incorporate into any yard. 2 slide gates & one swing gate. Works great with common calf cradles/ crushes. High sheeted sides & anti-jump bar to protect your calves. Australian Galvanised steel. \$3,950

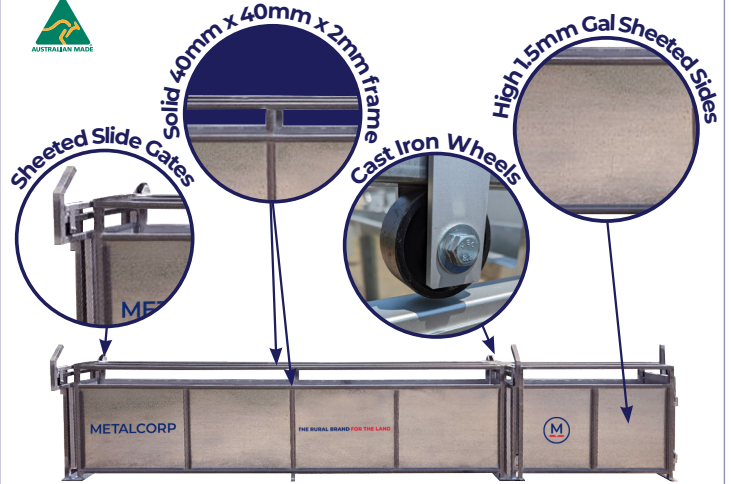

METALCORP MATES PRICE! **\$3,750** SAVE \$200!

CATTLEMASTER® Fixed 4m

Heavy duty. 115mm x 42mm oval rail. Overhead bracing.

\$3,123



CATTLEMASTER® Adjustable 4m

Heavy duty. Dual pin locking. 115mm x 42mm oval rail.

\$4,505



2026 Field Day Calendar

Keep an eye out for your local Metalcorp Team at these events throughout 2026. We are always keen to do a deal.



NQFD (Townsville)

FARMFEST

RICHMOND

AGROTREND

FIELD DAY Fri 29th May – Sat 30th May, Townsville Showgrounds.

FIELD DAY Tuesday 2nd - Thursday 4th June, Site G-H: 06-07.

FIELD DAY Friday 12th - Saturday 13th June, Industrial Area.

FIELD DAY Fri 11th Sep – Sat 12th Sep, Bundy Recreational Precinct.

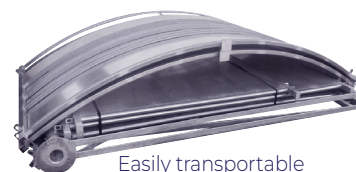

Easily transportable



Extra curve kit extension available

CATTLEMASTER® Safety Force

120° gate operation. Clockwise & anti-clockwise available. Sheeted for safety. Easy to erect. Anti-backing locking mechanism on gate for operator safety. 8mm thick flat bar supports for long life & non-trip hazards. Breaks down to be transportable. Add extra curve kit to make 180° Force.

\$8,275



CATTLE YARD RANGE

CATTLEKING® Yard Range

Heavy duty 5 rail top of the range yard components. Designed for safety with both the operator & livestock in mind. Our most popular range suited to most applications. CATTLEKING® panels are manufactured in Australia with high strength electrogalvanised Australian steel. This durable 5 rails system is strong & offers great visual deterrent. All panels can be connected to other Metalcorp brand panels. This is handy where a heavy panel is needed in the race & lighter panel can be used in the holding area.

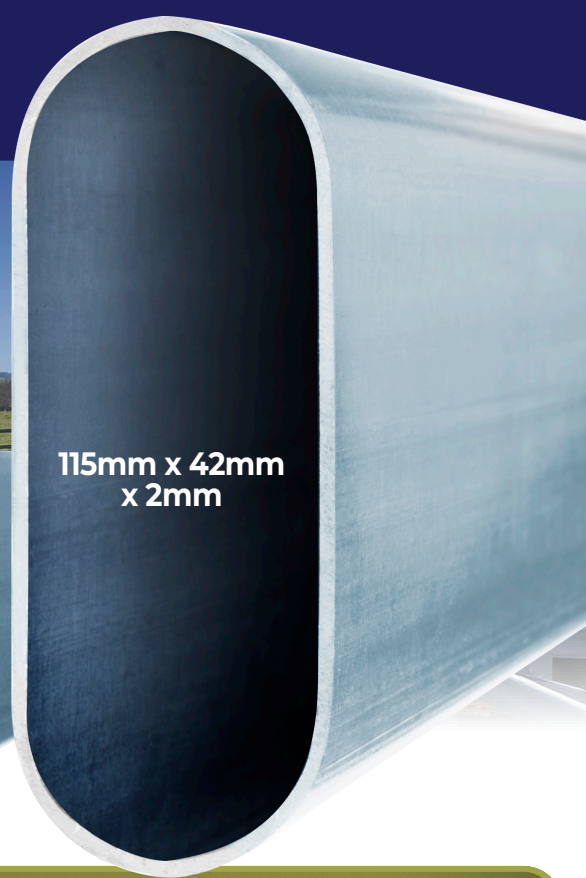

✓ Top of the range

✓ Made in Australia

✓ Australian steel

50mm x 50mm
x 2mm

115mm x 42mm
x 2mm

20C CATTLEMASTER® Cattle Yard

- ✓ Panel 2.25m x 7
- ✓ Panel 2.5m x 9
- ✓ Gate in frame 2.5m x 4
- ✓ Manway panel 2.5m x 1
- ✓ Slide gate x 1
- ✓ Race bow x 2
- ✓ Yard pin x 58

CHOOSE
YOUR OWN
CRUSH &
RAMP

\$6,430

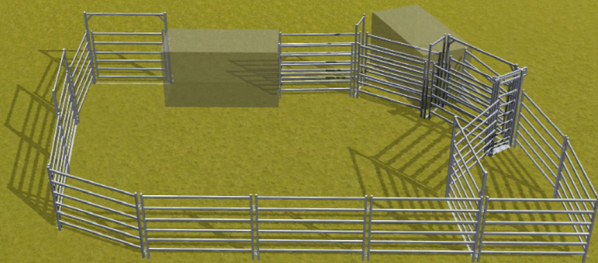

65C CATTLEMASTER® Cattle Yard

- ✓ Panel 2.25m x 11
- ✓ Panel 2.5m x 16
- ✓ Gate in frame 2.5m x 7
- ✓ Manway panel 2.5m x 1
- ✓ Slide gate x 1
- ✓ Race bow x 2
- ✓ Yard Pin x 86

CHOOSE
YOUR OWN
CRUSH &
RAMP

\$10,010

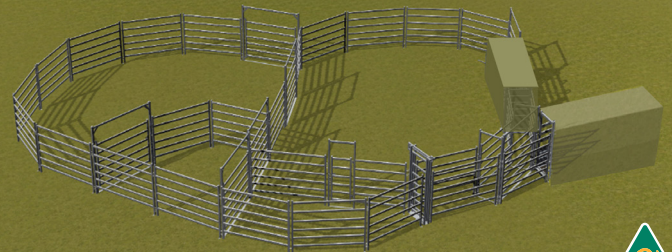

120C-P-SF CATTLEKING® Cattle Yard

- ✓ Safe-T-Force draft x 1
- ✓ Panel 2.25m x 9
- ✓ Panel 2.5m x 25
- ✓ Gate in frame 2.5m x 12
- ✓ Manway panel 2.5m x 1
- ✓ Slide gate x 1
- ✓ Race bow x 5
- ✓ Yard pin x 132

CHOOSE
YOUR OWN
CRUSH &
RAMP

\$17,875

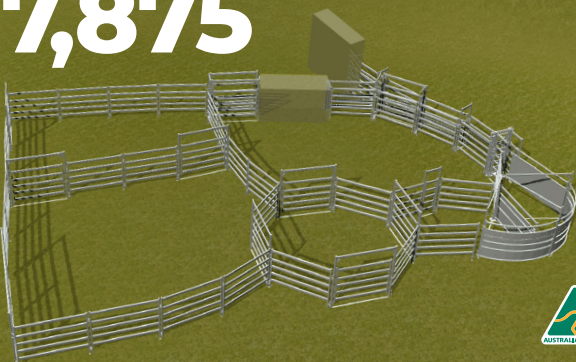

200C-P CATTLEKING® Cattle Yard

- ✓ Panel 2.25m x 11
- ✓ Panel 2.5m x 50
- ✓ Gate in frame 2.5m x 14
- ✓ Double gate in frame 5m x 1
- ✓ Slide gate x 1
- ✓ Race bow x 4
- ✓ Yard Pin x 176

CHOOSE
YOUR OWN
CRUSH &
RAMP

\$27,505

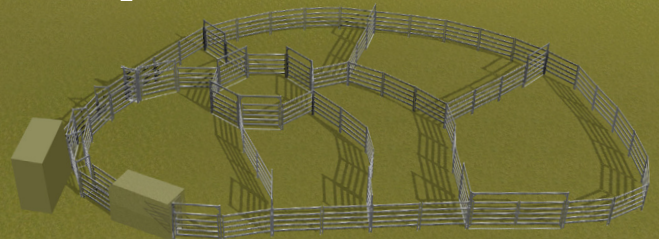

FEEDERS

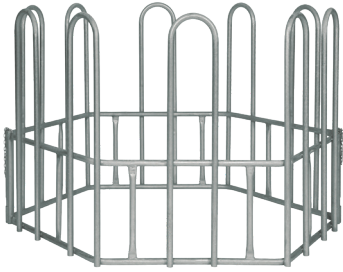

2 Piece Round Bale Feeder
1800mm (d), 1300mm (h)

\$374



LIMITED STOCKS - WHILE STOCKS LAST!



3t Double Sided Grain Feeder
Gal construction. Adjustable feed flow control.
\$3,913



METALCORP MATES PRICE! \$3,850 SAVE \$63!



Rubber Feeder
50nb M Gal pipe.
4000mm (l)
650mm (w)
500mm (h)

\$950

HORSE



Horse Handler
Provides a safe and secure environment for you and your horse.

\$3,248



SHEEP



NEW

2025 WINNER
Metalcorp Sheep Clamp System
Machine of the year
Australian National Field Days

Sheep Clamp
Designed to take the stress out of everyday tasks.

\$7,995

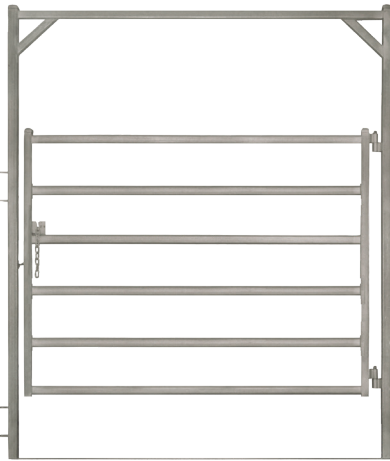

FARMHAND® Gate in Frame
6 bar. Gal. 59mm x 30mm oval rail.
2200mm (h) x 2100mm (w).

\$229



NEW

Sheep Goat Handler Flipper
Catch, restrain, roll, work & release them.

\$4,950



DOWNGRADE SPECIALS

TONNES OF DOWNGRADE RHS & PIPE IN STOCK.
Perfect for all those on farm jobs.
Package deals available.
See instore for full list.



MESH FOR EVERY JOB

REO Mesh
2.4m (w) x 6m (l).
SL72-----\$99
SL82-----\$120
from **\$99**



Gal Mesh Handy Sheets
1.2m (w) x 2m (l).
25mm x 25mm x 2.5-----\$33.00
50mm x 50mm x 4mm-----\$35.00
50mm x 75mm x 4mm-----\$33.00
100mm x 100mm x 4mm-----\$24.20
from **\$24.20**

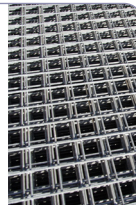

Gal Mesh Sheets
2.4m (w) x 3m (l).
25mm x 25mm x 2.5mm-----\$110.00
50mm x 50mm x 4mm-----\$105.00
50mm x 75mm x 4mm-----\$88.00
100mm x 100mm x 5mm-----\$90.00
from **\$88**



BUILD YOUR OWN YARD



NEED SOME AUSSIE CATTLE RAIL?

Contact your local branch for a competitive price today!



Rail Joiner
\$21

Rail Cap
from **\$7**

Rail Saddle
\$750

Rail End Brackets
\$26 pack

Fence Post Caps
from **\$2**

FENCING RANGE

Metalcorp Fence Posts. Built Tough for Every Boundary

Experience strength & dependability with Metalcorp fence posts

Made from high-grade billet steel built to Metalcorp specifications designed for durability. Our standard product features a heavy weight of 1.9 kg/m.

Features include accurate hole placement and spacing for a uniform fence. Smooth, uniformly cut ends for straightforward installation. Metalcorp delivers exceptional performance every time.

Our options

- Available in various lengths from 1350mm to 2400mm.
- Choose between heavy hot-dip galvanized finish or coated with a resilient black bituminous layer (not paint).
- Mega Post available on request.
- Clip Post available on request.
- Package deals available.
- Bundle it together with your METALMAX® fencing.
- Black Bitumen: 60-80 microns
- Hot Dipped Galvanised (500g/m²)

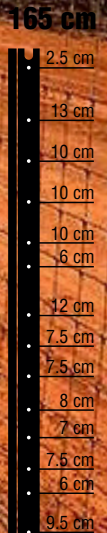
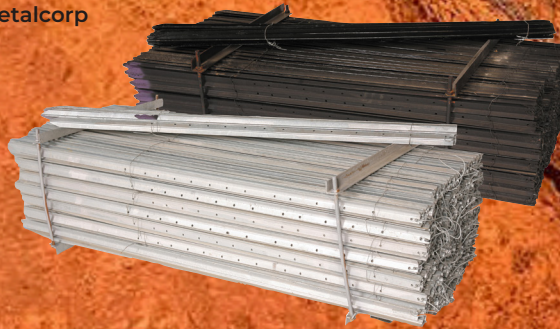

Hole size is 8mm

METALMAX FENCING IS MANUFACTURED IN AUSTRALIA

METALMAX® fencing heavily galvanised wire products have up to 5 times coating thickness than that of standard wires & are made to Australian Standards AS 2423-2002 & zinc coated to AS/NZS 4534-2006.

“MADE TOUGH FOR THE TOUGH AUSTRALIAN CONDITIONS”



10km x 4 Barb Wire FENCE PACKAGE

What You Get -

- ✓ Barb Wire 1.8mm HT 500m x 80
- ✓ Black Fence Post 1800mm x 2,000
- ✓ Post Clip with Tool 250 x 32
- ✓ Wire strainer & toolbox

\$23,650



BONUS WIRE STRAINER AND TOOLBOX with purchase



5km 7-90-30 FENCE PACKAGE

What You Get

- ✓ Black Fence Post 1800mm x 1,250
- ✓ METALMAX® 7-90-30 2.5mm Heavy Gal 200m x 20
- ✓ Barb wire 1.8mm HT 500m x 20
- ✓ Plain wire 2.5mm HT 1500m x 10
- ✓ Post Clip with Tool 250 x 9
- ✓ Clips 1000 x 10
- ✓ Hinge joint strainer

\$20,855



BONUS HINGE JOINT STRAINER with purchase



2km 16-180-15 FENCE PACKAGE

What You Get

- ✓ METALMAX® 16-180-15 2.5mm Heavy Gal 250m x 8
- ✓ Barb wire 1.8mm HT 500m x 4
- ✓ Fence Post LOCK-IT black 2,250mm x 500
- ✓ Hinge joint strainer

\$23,550



BONUS HINGE JOINT STRAINER with purchase



METALMAX®

METALMAX®

DID YOU KNOW THAT METALCORP CAN QUOTE YOU ON ANY FENCING PROJECT LARGE OR SMALL?

We can help with anything from a simple house paddock fence to a full blown exclusion fence. Reach out to your local branch, we would be more than happy to assist with your enquiry.

For fencing projects please contact

Matt Emmett
Northern Rural Manager
matthew.emmett@metalcopsteel.com.au
0407 732 594



from **\$194***



Fabricated Fence wire - Heavy Gal

7-90-30 2.5mm x 200m-----\$339*
8-90-15 2.5mm x 100m-----\$267*
8-115-15 2mm T&B x 100m-----\$194*
More sizes available.

METALMAX

PALLET BUY DEALS

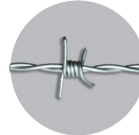

Barb Wire Heavy Gal

1.8mm x 500m HT-----	EOFY Frenzy rate \$124*	Mates rate \$121*
2.0mm x 500m HT-----	\$158*	\$155*
2.5mm x 400m IOWA standard gal----	\$145*	\$142*

*Pallet buy prices. 1.8mm x 36. 2.0mm & 2.5mm x 27 per pallet.

METALCORP MATES PRICE! **STARTING FROM \$121**

METALMAX

PACK BUY DEALS



from **\$41**

100nb x 3mm x 2100mm-----\$50
100nb x 4.5mm x 2400mm-----\$77
100nb x 4.5mm x 2700mm-----\$88
*100nb in 19 pack lots.

Stays Hot Dipped Gal

50nb x 5mm x 3250mm-----\$41
*50nb in 37 pack lots.



	EOFY Frenzy rate	Mates rate
2.5mm MT 1500m-----	\$203	\$197
2.5mm HT 1500m-----	\$200	\$194
3.15mm ST x 750m-----	\$156	\$151
4.0mm ST x 500m-----	\$158	\$154

METALCORP MATES PRICE! **STARTING FROM \$151**

PALLET BUY DEALS



Cattle Cable
8mm (d), 400m (l).
\$429*

*Pallet buy prices.
8 per pallet.

METALCORP MATES PRICE! **\$424*** **SAVE \$5!**

Strainer and Stay Assembly System.

Suits 100mm post.
Includes:
• 50mm top stay bracket.
• HPG ground plate.
• Stainless-steel cable.
Post & stay sold separately.

\$86



METALMAX FENCING IS MANUFACTURED IN AUSTRALIA

METALMAX® fencing heavily galvanized wire products have up to 5 times coating thickness than that of standard wires & are made to Australian Standards AS 2423-2002 & zinc coated to AS/NZS 4534-2006.

"MADE TOUGH FOR THE TOUGH AUSTRALIAN CONDITIONS"



METALMAX GATES SPECIALS

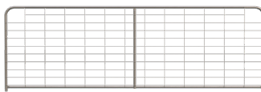

V-Brace 1170mm 25NB
(10') 2970mm-----\$117
(12') 3570mm-----\$134
from **\$117**

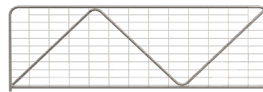

N-Stay 1170mm 25NB
(10') 2970mm-----\$128
(12') 3570mm-----\$146
(14') 4170mm-----\$172
from **\$128**

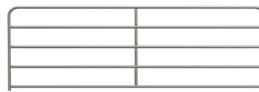

5 Bar 1170mm 25NB
(8') 2370mm-----\$111
(10') 2970mm-----\$128
(12') 3570mm-----\$139
from **\$111**



5 Bar 1170mm 32NB
(10') 2970mm-----\$160
(12') 3570mm-----\$173
(14') 4170mm-----\$226
from **\$160**

CLEARANCE! from \$50

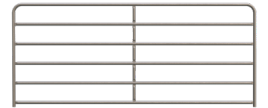

6 Bar 1490mm 32NB
(4') 1170mm-----\$50
(6') 1770mm-----\$59
(8') 2370mm-----\$115
(10') 2970mm-----\$138
(12') 3570mm-----\$155



Honda Petrol Post Driver
\$2,099



Motorised Wire Winder
5.5 hp Honda petrol engine. Belt driven on clutch side for easy servicing.
\$6,080



Hydraulic Wire Winder
Adjustable speed. Removable wheel. Replaceable bushing on shaft.
\$3,989

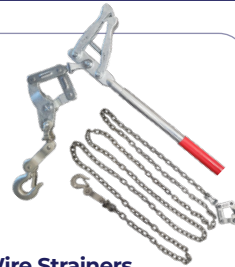

Wire Strainers
\$110
INC. BONUS TOOLBOX



NEW MODEL
Battery Operated Clip Gun Kit
Includes 2 x Battery, 1 x charger & hard case.
\$1,800

- Slams & Striker Plates
Various sizes available
\$6
- Permanent Wire Ratchets
from \$13
- Weld on Hinges
\$23
- Ring Fastener
\$45 20pack
- Fence Ender
\$45 20pack
- Speedy Wire Joiners
\$20 tub of 250
- Barb Wire Twist Ties
\$187
- Hinged Joint Strainer
\$70
- Post Driver
\$110
- Post Lifter
\$150
- Wire Spinner
\$99
- Clip Gun
\$30
- Fencing Pliers
\$44
- Wire Cutters
\$11 400gm
- Silver Zinc Spray Paint
\$11 400gm

CATTLEMASTER® Crush

**A genuine all-rounder.
Built for strength,
durability, and versatility**

Manufactured from premium, heavy-duty Australian steel and proudly made right here in Australia, the CATTLEMASTER® Crush is built to endure the harshest farming conditions while prioritising the safety of both livestock and handlers.

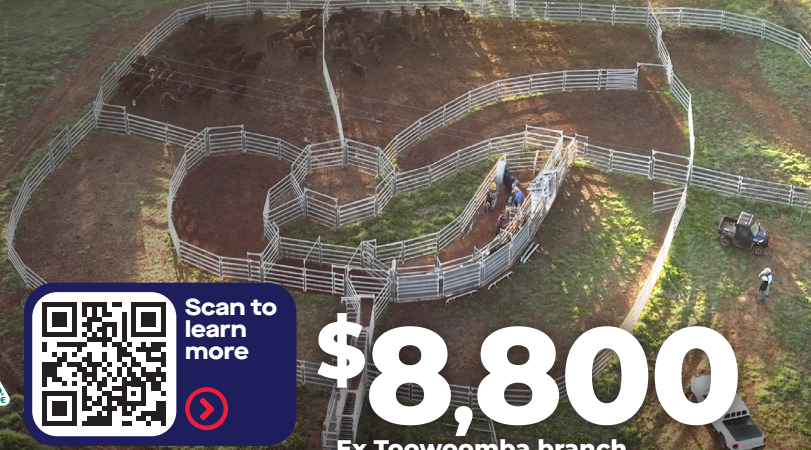

NEW & IMPROVED

**IN STOCK
READY FOR
DELIVERY**

**12 month
warranty**
on crush from
purchase
date



\$8,800

**Ex Toowoomba branch.
Freight extra to other branches.**



- 1 Offside operation available on request.
- 2 All welds painted using 98.5% pure zinc spray.
- 3 115mm x 42mm non-bruise cattle rail.
- 4 Forward & rear ratchet operated headball.
- 5 Walk-through vet section.
- 6 Powder coated handles.
- 7 Slam latch enables quick hands free closing.
- 8 Increased lower vet gate height to reduce risk of kick back from the animal.
- 9 Foot operated lower vet door (operating side).
- 10 Anti-reverse mechanism has 850mm of adjustment.
- 11 Pressed Gal sheeting.
- 12 Split operating gates on both sides.
- 13 Base 75mm x 50mm x 4mm.
- 14 Upright frame 75mm x 50mm x 2.5mm.
- 15 All 50mm x 50mm RHS are 2.5mm.
- 16 Metalcorp crushes come standard with chin bar.

Compatible with all major weighing systems.

Ratchet squeeze adjusts in precise 40mm increments for optimal cattle restraint.

One hand quick release chin bar.

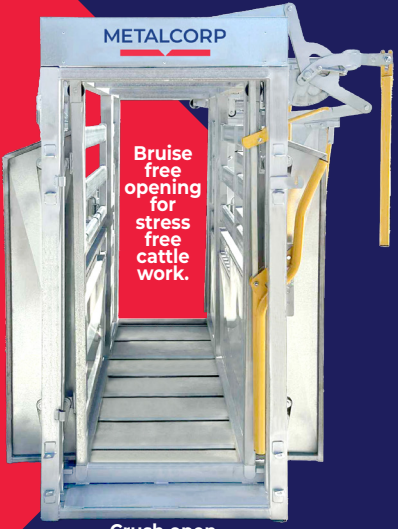

Crush open width is 720mm

16mm BIMALLOY® Wear 450 steel plate ratchet and pawl with dual locking springs. All components precision cut and zinc plated.



Zinc-plated 20mm slam latch with stainless steel springs.



All hinges are a solid 20mm thick pin with removable linch pin for complete access.



Fully sheeted telescopic rear slide gate with one hand function. Helps create a blind race to reduce stress on livestock.



Main side doors operate separately or lock together with 20mm vertical slam latch.

75mm oil-able cast iron rollers.



All nuts are NYLOC.



Needle gate opening 440mm x 660mm.



Drop away handles can be easily locked into position.



Our Sales Network

Metalcorp Bundaberg	21 Charlie Triggs Cr	07 4130 0101
Metalcorp Charters Towers	Hugh Quinn Cr	07 4763 7624
Metalcorp Northgate	920 Nudgee Rd	07 3837 9546
Metalcorp Toowoomba	340-360 Anzac Av	07 4592 7400
BlueScope Distribution Mt Isa	1 Richardson Rd	07 4437 4600

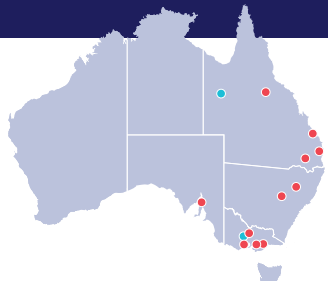

METALCORN

Everything in Steel

**THE RURAL BRAND
FOR THE LAND**